

Lazy Susan

Traditional Chinese Model
Diagram by Andrew Hudson

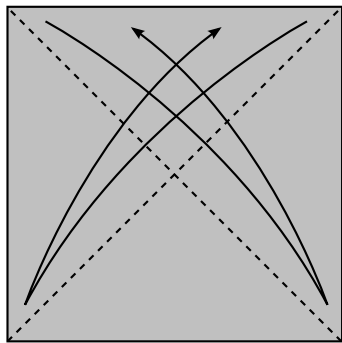

1.

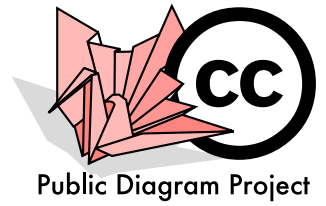
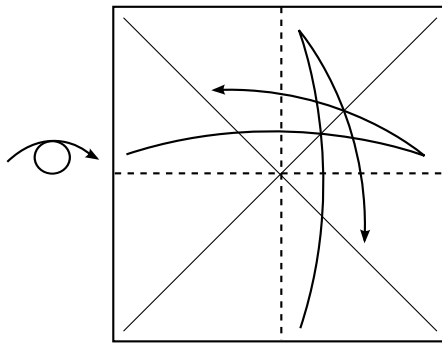

2.

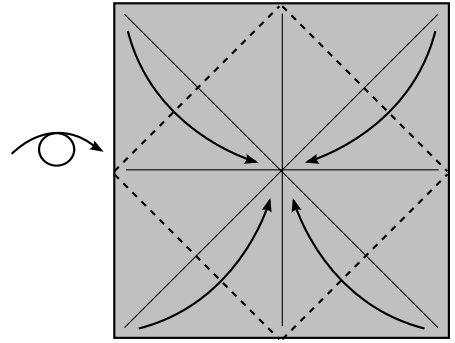

3.

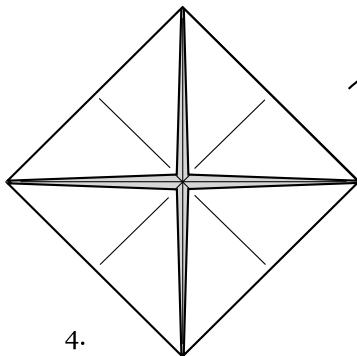

4.

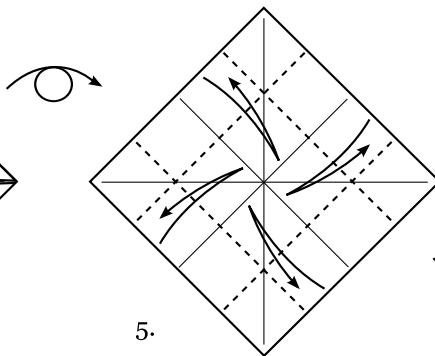

5.

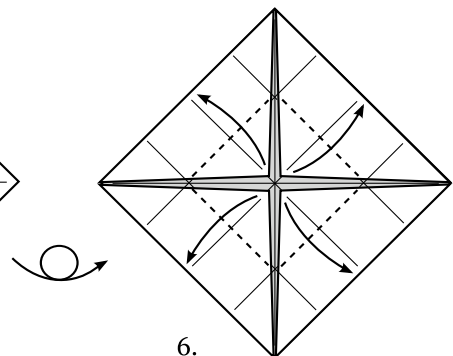

6.

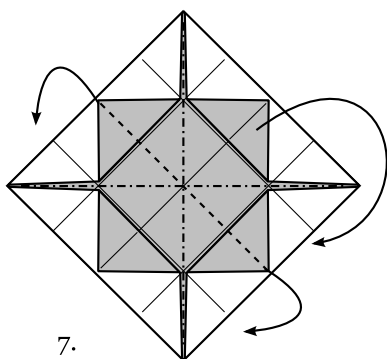

7.

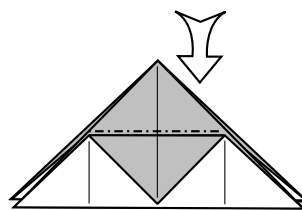

8.

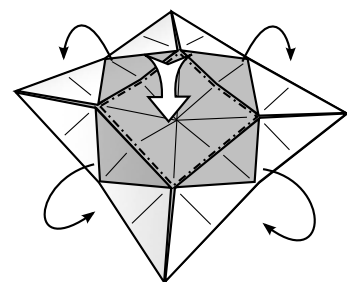

9.

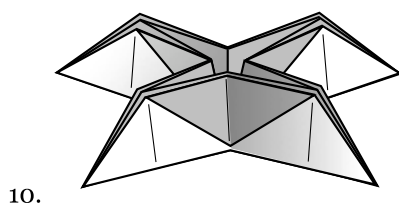

10.

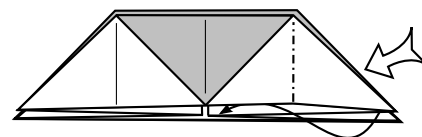

11.

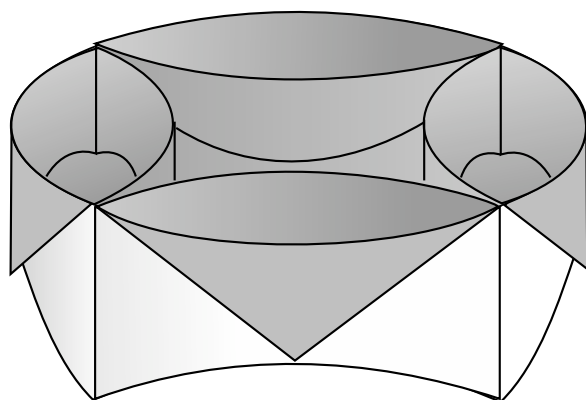
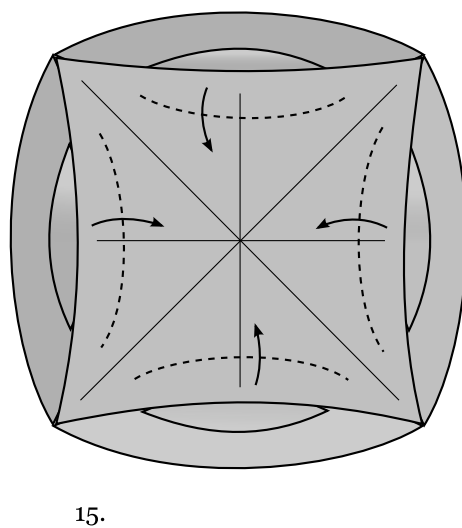
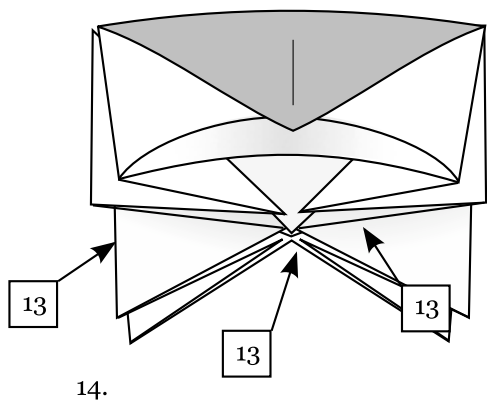
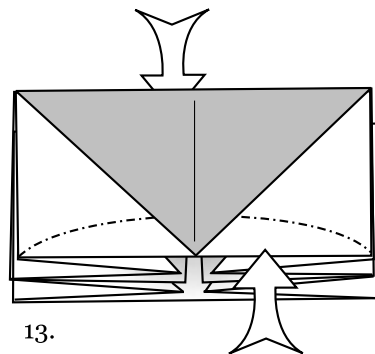
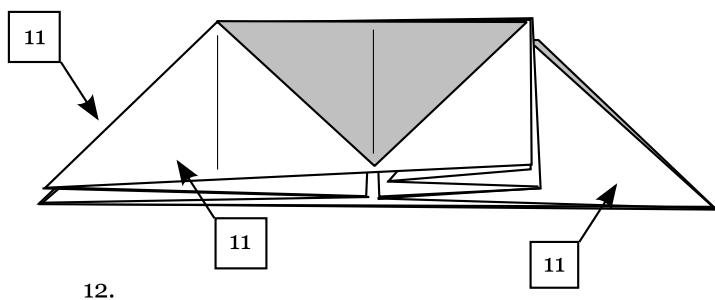

Finished



You are free to share or adapt this origami diagram for any purpose.

This work is licensed under the Creative Commons Attribution 3.0 United States License. To view a copy of this license, visit <http://creativecommons.org/licenses/by/3.0/us/> or send a letter to Creative Commons, 171 Second Street, Suite 300, San Francisco, California, 94105, USA.